

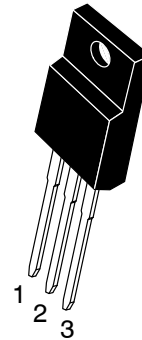

Features

- Metal silicon junction, majority carrier conduction
- Plastic material used carries Underwriters Laboratory Classifications 94V-0
- High surge capability
- Low power loss, high efficiency
- High current capability, low forward voltage drop
- For use in low voltage, high frequency inverters, free wheeling, and polarity protection applications
- Guardring for overvoltage protection
- High temperature soldering guaranteed: 260°C/10 seconds, at terminals
- Green compound with suffix "G" on packing code & prefix "G" on datecode.

TO-220F



Mechanical Data

- Case: TO-220F molded plastic body
- Polarity: As marked
- Terminals: Pure tin plated, lead free, solderable per MIL-STD-750, Method 2026
- Mounting position: Any
- Weight: 1.7grams
- Mounting torque: 5 in. - lbs. max

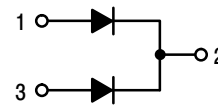

Marking Diagram



- Y = Year
- A = Assembly Location
- WW = Work Week
- MBRF20XX = Specific Device Code

Maximum Ratings and Electrical Characteristics

Rating at 25 °C ambient temperature unless otherwise specified.
 Single phase, half wave, 60 Hz, resistive or inductive load.
 For capacitive load, derate current by 20%

Type Number	Symbol	MBRF 2040 CTG	MBRF 2045 CTG	MBRF 2050 CTG	MBRF 2060 CTG	MBRF 2080 CTG	MBRF 2090 CTG	MBRF 20100 CTG	MBRF 20150 CTG	MBRF 20200 CTG	Unit
Maximum Repetitive Peak Reverse Voltage	V_{RRM}	40	45	50	60	80	90	100	150	200	V
Maximum RMS Voltage	V_{RMS}	28	31	35	42	56	63	70	105	140	V
Maximum DC Blocking Voltage	V_{DC}	40	45	50	60	80	90	100	150	200	V
Maximum Average Forward Rectified Current at $T_c=135^\circ\text{C}$	$I_{F(AV)}$	20									A
Peak Repetitive Forward Current (Rated VR, Square Wave, 20KHz) at $T_c=135^\circ\text{C}$	I_{FRM}	20									A
Peak Forward Surge Current, 8.3 ms Single Half Sine-wave Superimposed on Rated Load (JEDEC method)	I_{FSM}	150									A
Peak Repetitive Reverse Surge Current (Note 1)	I_{RRM}	1			0.5						A
Maximum Instantaneous Forward Voltage (Note 2) IF=10A, TA=25°C IF=10A, TA=125°C IF=20A, TA=25°C IF=20A, TA=125°C	V_F	0.70 0.55 0.80 0.70		0.74 0.60 0.85 0.74		0.76 0.62 0.86 0.75		0.80 0.70 0.90 0.80		0.85 0.75 0.95 0.85	V
Maximum Reverse Current @ Rated VR $T_A=25^\circ\text{C}$ $T_A=125^\circ\text{C}$	I_R	0.02		0.01		0.002		0.0045		0.0002	mA
Voltage Rate of Change (Rated V_R)	dV/dt	10,000									V/us
Typical Junction Capacitance	C_j	400			320						pF
RMS Isolation Voltage (MBRF Type Only) from Terminals to Heatsink with $t=1.0$ Second, $RH \leq 30\%$	V_{ISO}	4500(Note 3) 3500(Note 4) 1500(Note 5)									V
Typical Thermal Resistance Per Leg	$R_{\theta JC}$	1.0			2.0						°C/W
Operating Temperature Range	T_J	- 65 to + 175									°C
Storage Temperature Range	T_{STG}	- 65 to + 175									°C

Note 1: 2.0uS Pulse Width, f=1.0KHz
 Note 2: Pulse Test : 300uS Pulse Width, 1% Duty Cycle
 Note 3: Clip Mounting (on case), where lead does not overlap heatsink with 0.11" offset
 Note 4: Clip Mounting (on case), where lead does not overlap heatsink
 Note 5: Screw Mounting screw, where diameter is $\leq 4.9\text{mm}$ (0.1931"). www.First-semi.com



RATINGS AND CHARACTERISTIC CURVES

FIG. 1 FORWARD CURRENT DERATING CURVE

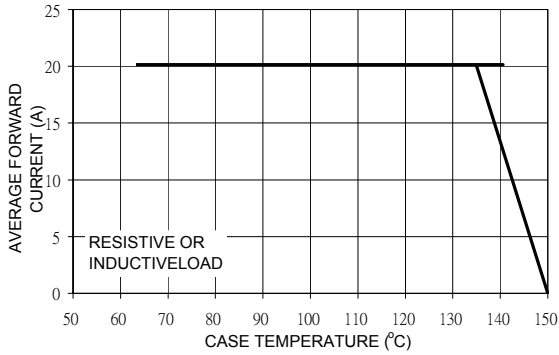

FIG. 2 MAXIMUM NON-REPETITIVE FORWARD SURGE CURRENT PER LEG

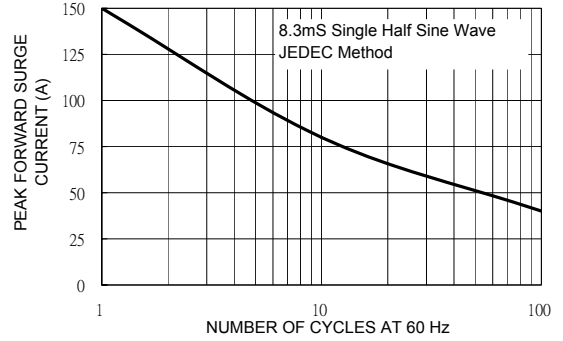

FIG. 3 TYPICAL FORWARD CHARACTERISTICS PER LEG

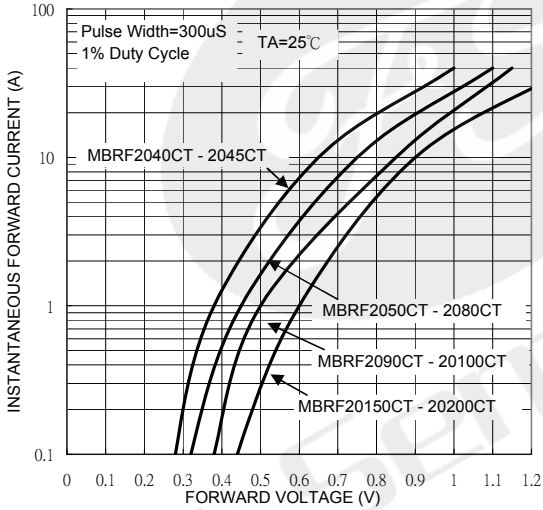

FIG. 4 TYPICAL REVERSE CHARACTERISTICS PER LEG

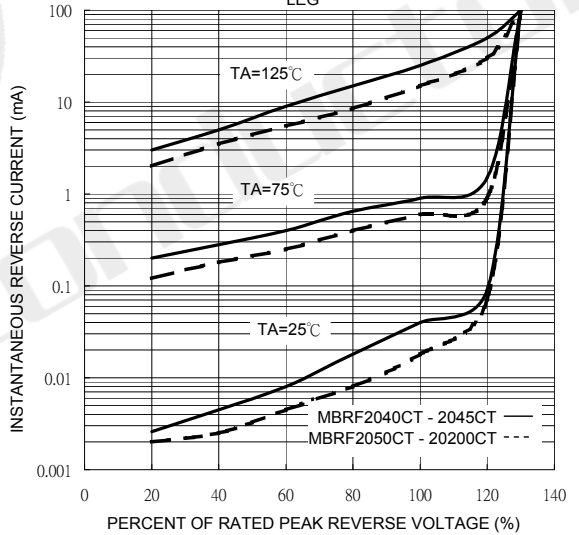

FIG. 5 TYPICAL JUNCTION CAPACITANCE PER LEG

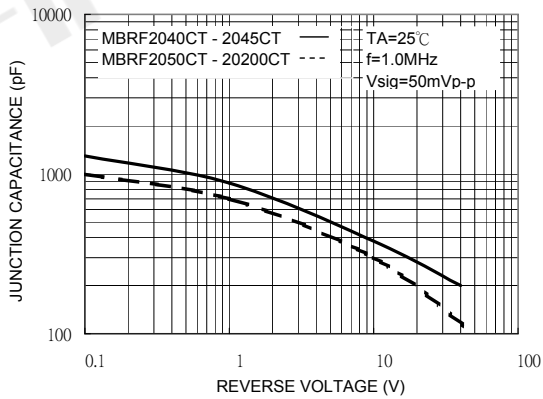
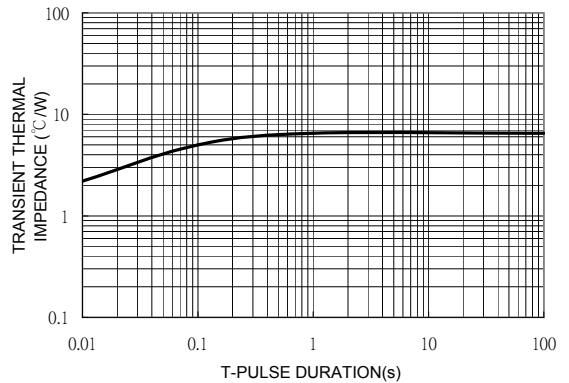
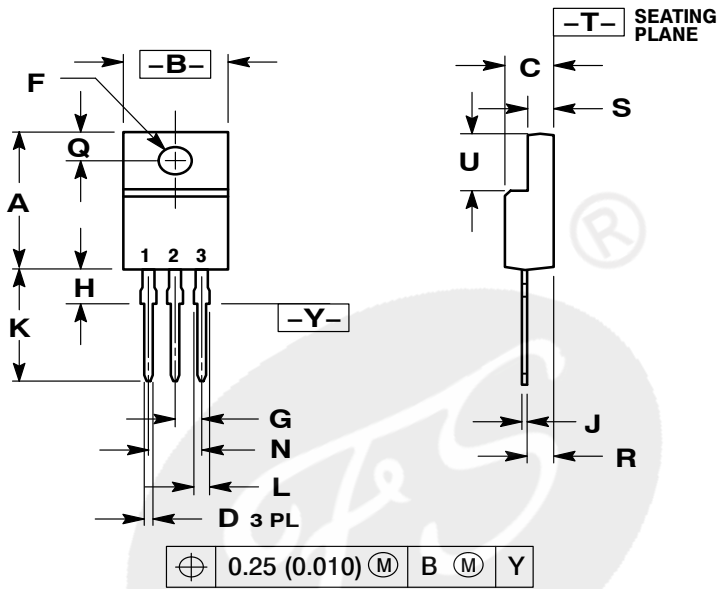

FIG. 6 TYPICAL TRANSIENT THERMAL IMPEDANCE PER LEG





TO-220F



- NOTES:
1. DIMENSIONING AND TOLERANCING PER ANSI Y14.5M, 1982.
 2. CONTROLLING DIMENSION: INCH
 3. 221D-01 THRU 221D-02 OBSOLETE, NEW STANDARD 221D-03.

DIM	INCHES		MILLIMETERS	
	MIN	MAX	MIN	MAX
A	0.617	0.635	15.67	16.12
B	0.392	0.419	9.96	10.63
C	0.177	0.193	4.50	4.90
D	0.024	0.039	0.60	1.00
F	0.116	0.129	2.95	3.28
G	0.100 BSC		2.54 BSC	
H	0.118	0.135	3.00	3.43
J	0.018	0.025	0.45	0.63
K	0.503	0.541	12.78	13.73
L	0.048	0.058	1.23	1.47
N	0.200 BSC		5.08 BSC	
Q	0.122	0.138	3.10	3.50
R	0.099	0.117	2.51	2.96
S	0.092	0.113	2.34	2.87
U	0.239	0.271	6.06	6.88



Declaration

- FIRST reserves the right to change the specifications, the same specifications of products due to different packaging line mold, the size of the appearance will be slightly different, shipped in kind, without notice! Customers should obtain the latest version information before ordering, and verify whether the relevant information is complete and up-to-date.
- Any semiconductor product under certain conditions has the possibility of failure or failure, The buyer has the responsibility to comply with safety standards and take safety measures when using FIRST products for system design and manufacturing, To avoid To avoid potential failure risks, which may cause personal injury or property damage!
- Product promotion endless, our company will wholeheartedly provide customers with better products!

ATTACHMENT

Revision History

Date	REV	Description	Page
2018.01.01	1.0	Initial release	

