



PIN Connection TO-252(D-PAK)

General Description

FIR7N65LG , the silicon N-channel Enhanced VDMOSFETs, is obtained by the self-aligned planar Technology which reduce the conduction loss, improve switching performance and enhance the avalanche energy. The transistor can be used in various power switching circuit for system miniaturization and higher efficiency. The package form is TO-252 , which accords with the RoHS standard.

Features

- | Fast Switching
- | Low ON Resistance
- | Low Gate Charge
- | Low Reverse transfer capacitances
- | 100% Single Pulse avalanche energy Test

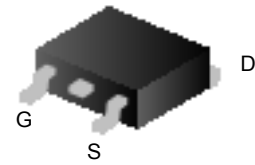

Schematic diagram

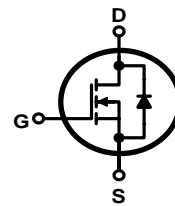

Marking Diagram

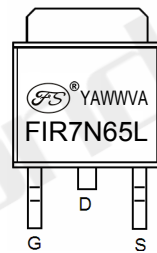

- Y = Year
- A = Assembly Location
- WW = Work Week
- VA = Version & Assembly plant
- FIR7N65L = Specific Device Code

Absolute Maximum Ratings (Ta = 25°C unless otherwise noted; reference only)

Characteristics	Symbol	Ratings	Unit
Drain-Source Voltage	V_{DS}	650	V
Gate-Source Voltage	V_{GS}	± 30	V
Drain Current	I_D	$T_C=25^\circ C$	7.0
		$T_C=100^\circ C$	4.4
Drain Current Pulsed	I_{DM}	28	A
Power Dissipation($T_C=25^\circ C$) -Derate above 25°C	P_D	100	W
		0.8	W/°C
Single Pulsed Avalanche Energy(Note 1)	E_{AS}	350	mJ
Operation Junction Temperature Range	T_J	-55~+150	°C
Storage Temperature Range	T_{stg}	-55~+150	°C

**Thermal Characteristics**

Characteristics	Symbol	Ratings	Unit
Thermal Resistance, Junction-to-Case	$R_{\theta JC}$	1.25	$^{\circ}C/W$
Thermal Resistance, Junction-to-Ambient	$R_{\theta JA}$	110	$^{\circ}C/W$

Electrical Characteristics (Ta = 25°C unless otherwise noted; reference only)

Characteristics	Symbol	Test conditions	Min.	Typ.	Max.	Unit
Drain -Source Breakdown Voltage	B_{VDSS}	25 °C, $V_{GS}=0V$, $I_D=250\mu A$	650	--	--	V
		125 °C, $V_{GS}=0V$, $I_D=250\mu A$	650	--	--	V
Drain-Source Leakage Current	I_{DSS}	25 °C, $V_{DS}=650V$, $V_{GS}=0V$	--	--	1	μA
		125 °C, $V_{DS}=520V$, $V_{GS}=0V$	--	--	100	μA
		150 °C, $V_{DS}=520V$, $V_{GS}=0V$	--	--	100	μA
Gate-Source Leakage Current	I_{GSS}	$V_{GS}=\pm 30V$, $V_{DS}=0V$	--	--	± 100	nA
Gate Threshold Voltage	$V_{GS(th)}$	$V_{GS}=V_{DS}$, $I_D=250\mu A$	2.0	--	4.0	V
Static Drain- Source On State Resistance	$R_{DS(on)}$	$V_{GS}=10V$, $I_D=2A$	--	1.2	1.4	Ω
Input Capacitance	C_{iss}	$V_{DS}=25V$, $V_{GS}=0V$, $f=1.0MHz$	--	1130	--	pF
Output Capacitance	C_{oss}		--	93	--	
Reverse Transfer Capacitance	C_{rss}		--	5.5	--	
Turn-on Delay Time	$t_{d(on)}$	$V_{DD}=325V$, $I_D=4.0A$, $R_G=10\Omega$ (Note 2,3)	--	19	--	ns
Turn-on Rise Time	t_r		--	21	--	
Turn-off Delay Time	$t_{d(off)}$		--	42	--	
Turn-off Fall Time	t_f		--	19	--	
Total Gate Charge	Q_g	$V_{DS}=520V$, $I_D=4.0A$, $V_{GS}=10V$ (Note 2,3)	--	24	--	nC
Gate-Source Charge	Q_{gs}		--	5.1	--	
Gate-Drain Charge	Q_{gd}		--	9.5	--	

Source-Drain Diode Ratings And Characteristics

Characteristics	Symbol	Test conditions	Min.	Typ.	Max.	Unit
Continuous Source Current	I_S	Integral Reverse P-N Junction Diode in the MOSFET	--	--	7.0	A
Pulsed Source Current	I_{SM}		--	--	28	
Diode Forward Voltage	V_{SD}	$I_S=4.0A$, $V_{GS}=0V$	--	--	1.5	V
Reverse Recovery Time	T_{rr}	$I_S=4.0A$, $V_{GS}=0V$,	--	382	--	ns
Reverse Recovery Charge	Q_{rr}	$dI_F/dt=100A/\mu s$	--	1980	--	nC

Notes:

- $L=10mH$, $I_{AS}= 8.4A$, $V_{DD}=100V$, $R_G=10\Omega$, starting $T_J=25^{\circ}C$;
- Pulse Test: Pulse width $\leq 300\mu s$, Duty cycle $\leq 2\%$;
- Essentially independent of operating temperature.



Characteristics Curve:

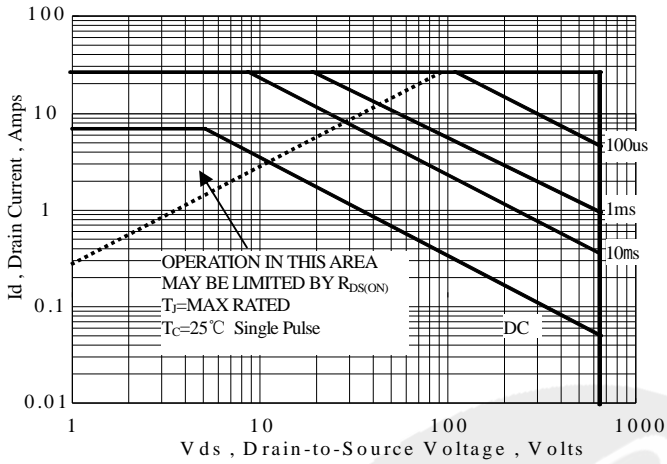

Figure 1 Maximum Forward Bias Safe Operating Area

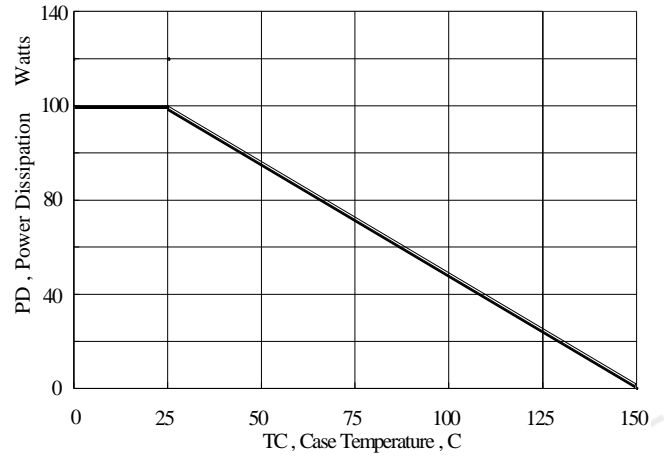

Figure 2 Maximum Power Dissipation vs Case Temperature

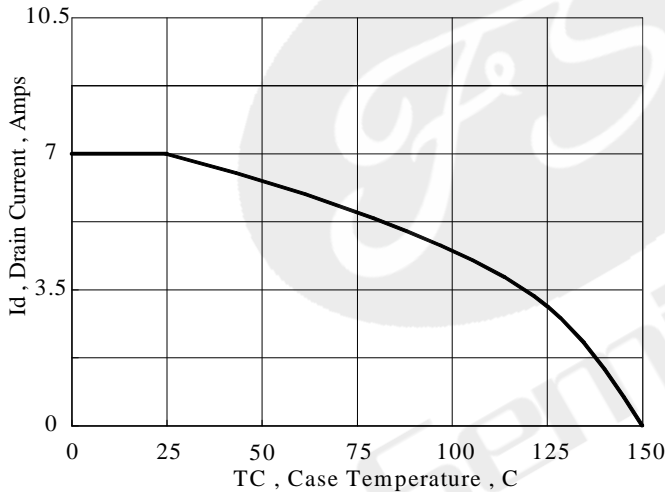

Figure 3 Maximum Continuous Drain Current vs Case Temperature

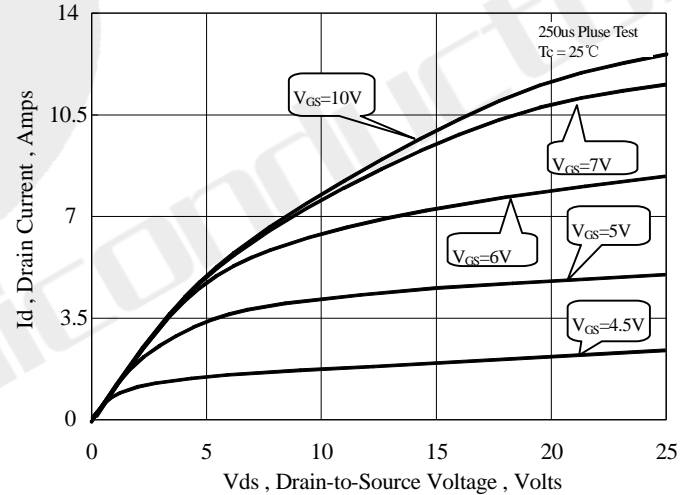

Figure 4 Typical Output Characteristics

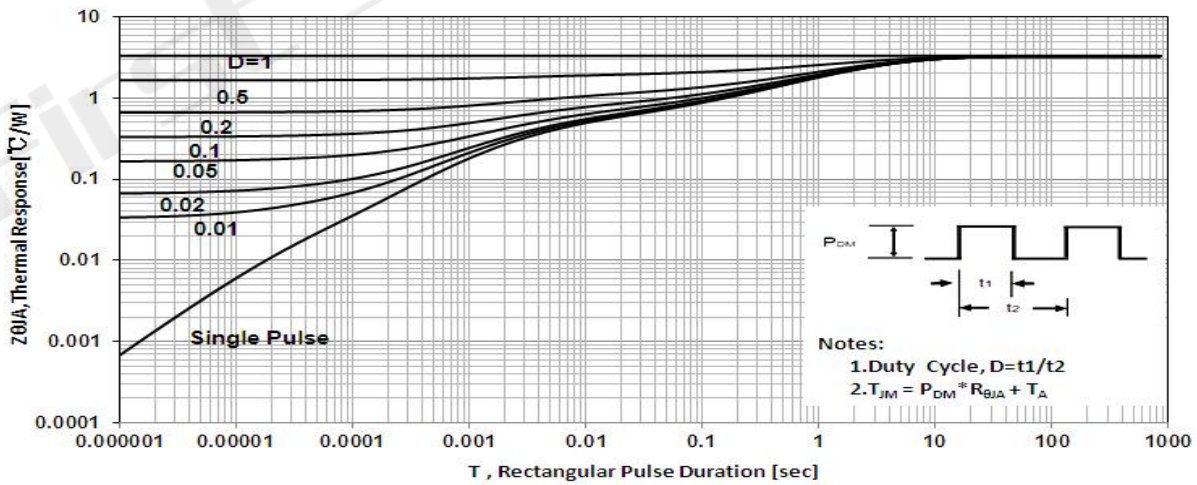

Figure 5 Maximum Effective Thermal Impedance function to Case

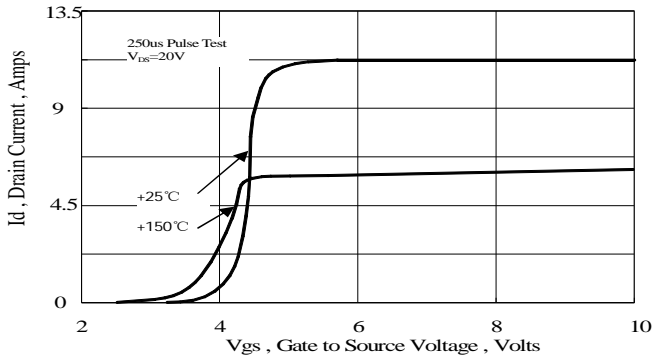

Figure 6 Typical Transfer Characteristics

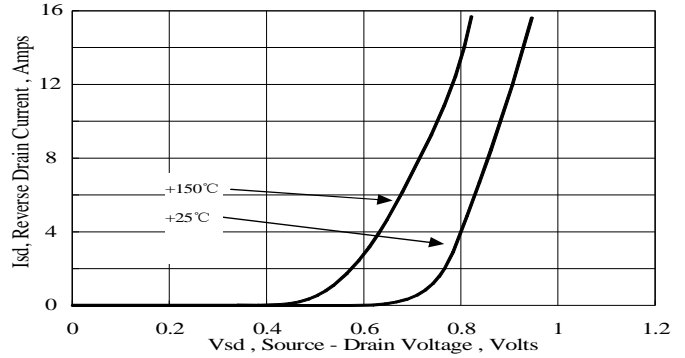

Figure 7 Typical Body Diode Transfer Characteristics

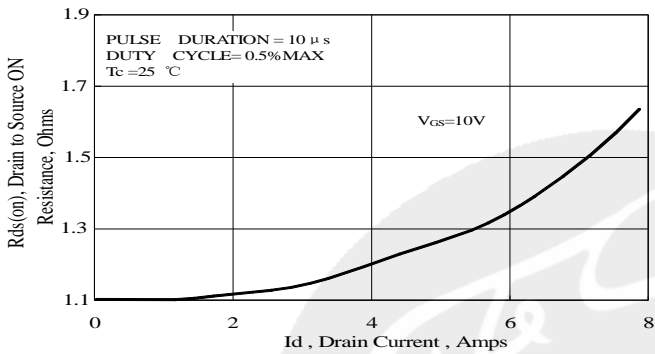

Figure 8 Typical Drain to Source ON Resistance vs Drain Current

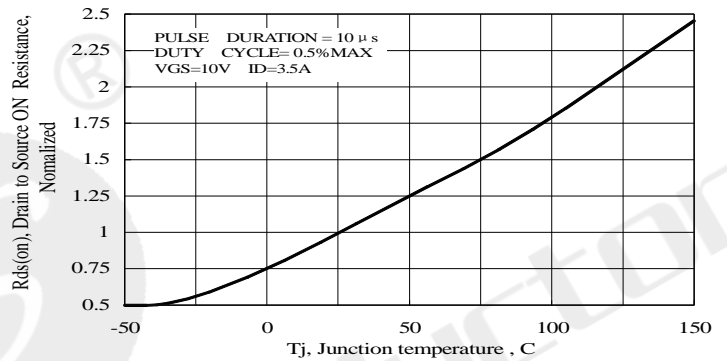

Figure 9 Typical Drain to Source on Resistance vs Junction Temperature

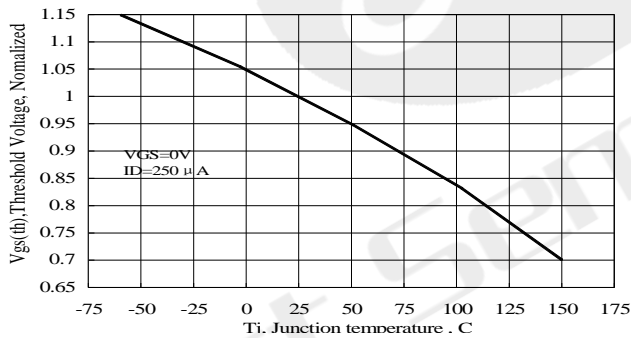

Figure 10 Typical Threshold Voltage vs Junction Temperature

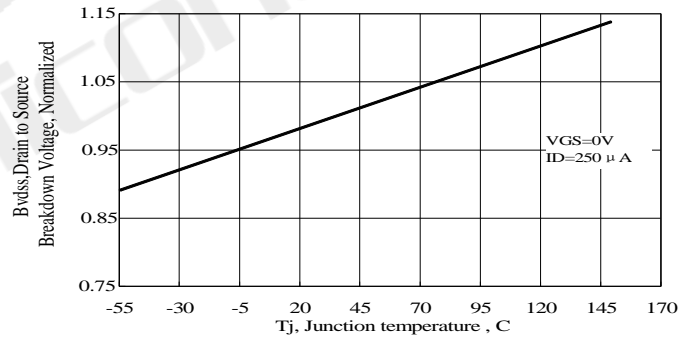

Figure 11 Typical Breakdown Voltage vs Junction Temperature

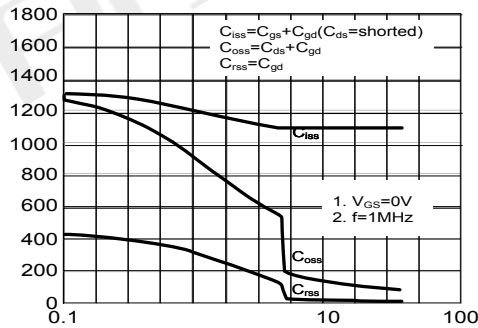

Figure 12 Typical Capacitance vs Drain to Source Voltage

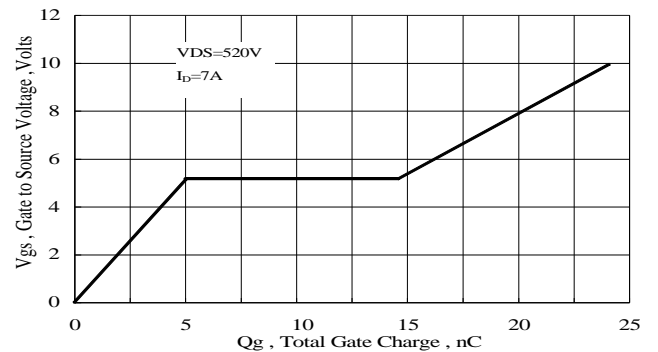

Figure 13 Typical Gate Charge vs Gate to Source Voltage

Test Circuit and Waveform

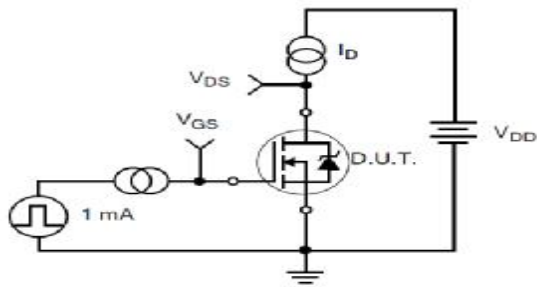

Figure 17. Gate Charge Test Circuit

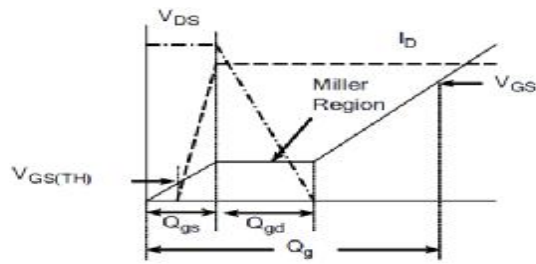

Figure 18. Gate Charge Waveform

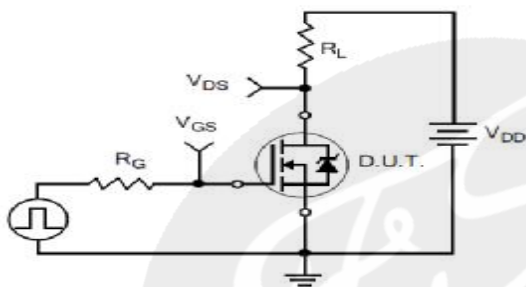

Figure 19. Resistive Switching Test Circuit

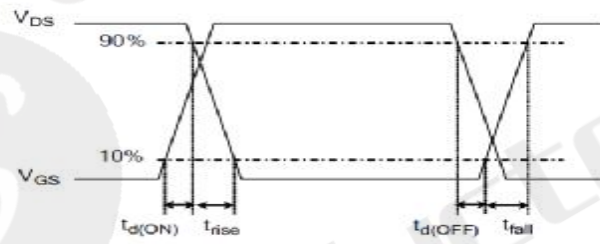

Figure 20. Resistive Switching Waveforms

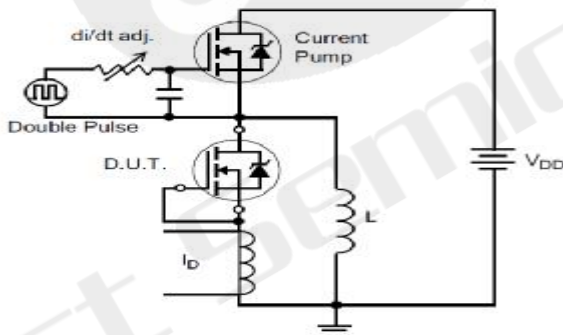

Figure 21. Diode Reverse Recovery Test Circuit

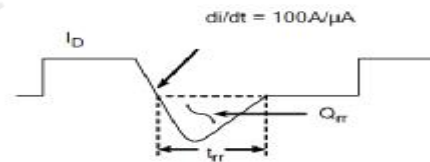

Figure 22. Diode Reverse Recovery Waveform

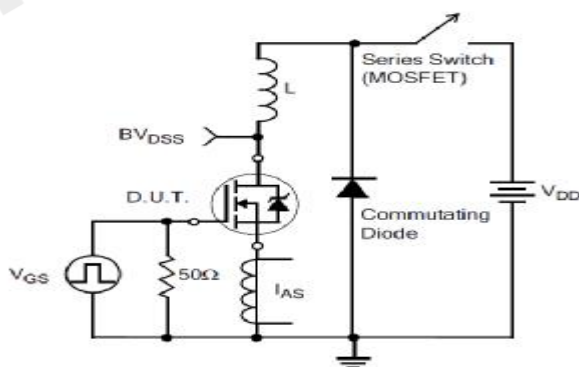

Figure 23. Unclamped Inductive Switching Test Circuit

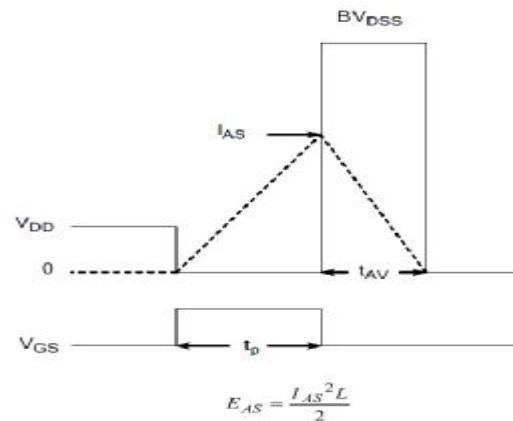
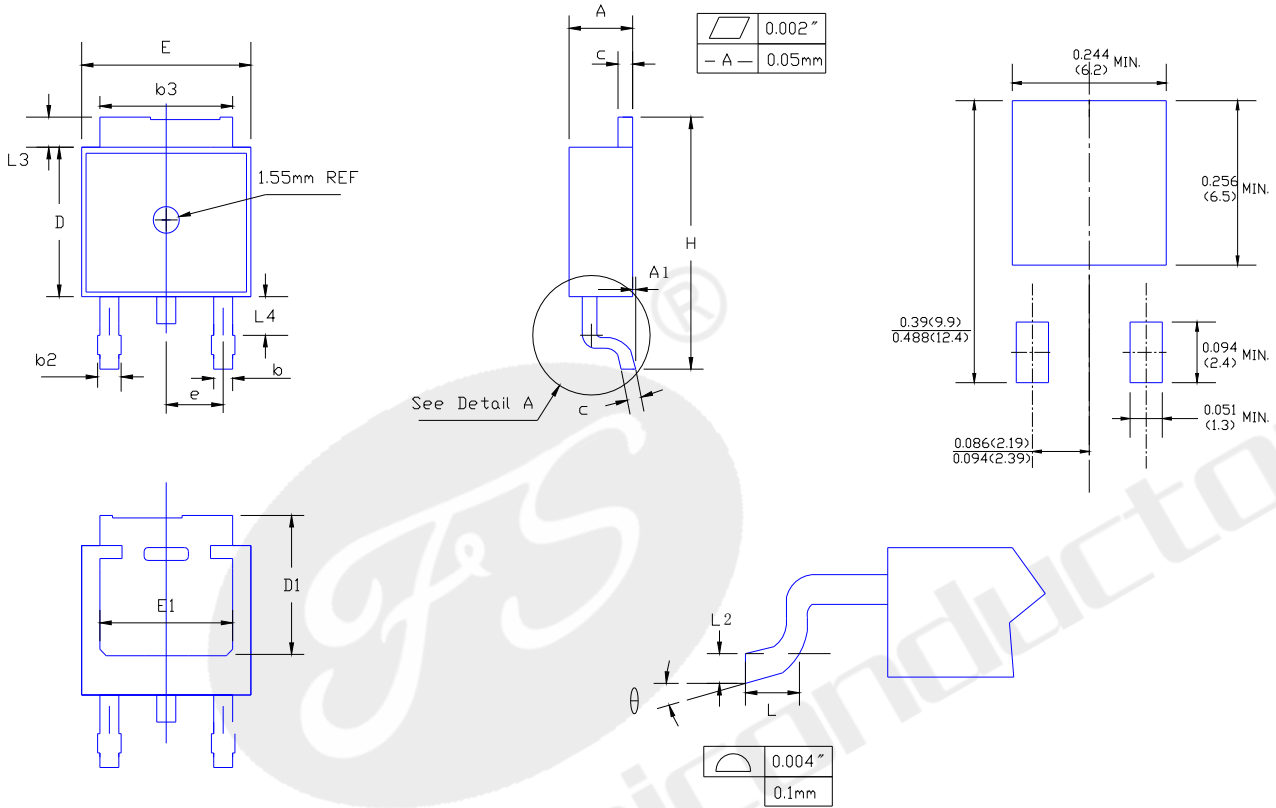

Figure 24. Unclamped Inductive Switching Waveforms

Package Dimensions

TO-252

Units: mm



SYMBOL	INCHES		MILLIMETERS		NOTES
	MIN	MAX	MIN	MAX	
A	0.086	0.094	2.19	2.38	
A1	-	0.005	-	0.13	
b	0.025	0.035	0.64	0.89	
b2	0.033	0.045	0.84	1.14	
b3	0.205	0.215	5.21	5.46	
c	0.018	0.024	0.46	0.61	
D	0.241	0.249	6.12	6.32	
D1	0.205	-	5.21	-	
E	0.250	0.265	6.35	6.73	
E1	0.190	-	4.83	-	
e	0.090 BSC.		2.29 BSC.		
H	0.380	0.410	9.65	10.41	
L	0.055	0.070	1.40	1.78	
L2	0.020 BSC.		0.51 BSC.		
L3	0.035	0.050	0.89	1.27	
L4	0.025	0.040	0.64	1.01	
	0°	8°	0°	8°	



Declaration

- FIRST reserves the right to change the specifications, the same specifications of products due to different packaging line mold, the size of the appearance will be slightly different, shipped in kind, without notice! Customers should obtain the latest version information before ordering, and verify whether the relevant information is complete and up-to-date.
- Any semiconductor product under certain conditions has the possibility of failure or failure, The buyer has the responsibility to comply with safety standards and take safety measures when using FIRST products for system design and manufacturing, To avoid To avoid potential failure risks, which may cause personal injury or property damage!
- Product promotion endless, our company will wholeheartedly provide customers with better products!

ATTACHMENT

Revision History

Date	REV	Description	Page
2018.01.01	1.0	Initial release	