



N-channel 100V, 1A, SOT-23 Power MOSFET 功率场效应管

■ Features 特點

Low on-resistance and maximum DC current capability 低導通電阻和最大直流電流能力

Super high density cell design 超高元胞密度設計

$R_{DS(ON)}$ TYP520m Ω @VGS=10V

$R_{DS(ON)}$ TYP550m Ω @VGS=4.5V

■ Applications 应用

Boost Converter 升壓轉換

Synchronous Rectifier 同步整流

LED Backlighting LED 背光驅動

■ Internal Schematic Diagram 内部结构

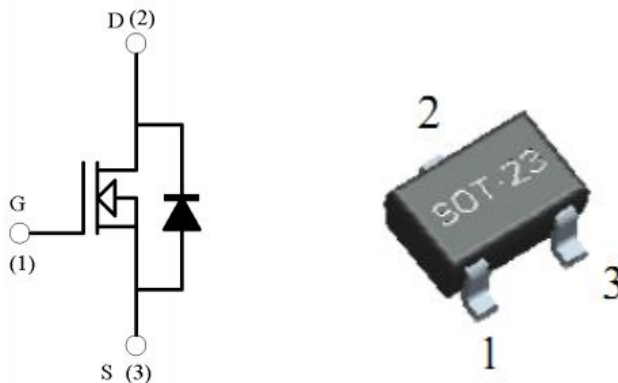

■ Absolute Maximum Ratings 最大额定值

Characteristic 特性參數	Symbol 符號	Rat 额定值	Unit 單位
Drain-Source Voltage 漏極-源極電壓	BV_{DSS}	100	V
Gate- Source Voltage 柵極-源極電壓	V_{GS}	± 20	V
Drain Current (continuous)漏極電流-連續	I_D (at $T_C = 25^\circ C$)	1	A
Drain Current (pulsed)漏極電流-脉冲	I_{DM}	4	A
Total Device Dissipation 總耗散功率	P_{TOT} (at $T_C = 25^\circ C$)	1.4	W
Thermal Resistance Junction-Ambient 熱阻	$R_{\theta JA}$	100	$^\circ C/W$
Junction/Storage Temperature 結溫/儲存溫度	T_J, T_{stg}	-55~150	$^\circ C$



■ Electrical Characteristics 電特性

($T_A=25^{\circ}\text{C}$ unless otherwise noted 如無特殊說明，溫度為 25°C)

Characteristic 特性參數	Symbol 符號	Min 最小值	Typ 典型值	Max 最大值	Unit 單位
Drain-Source Breakdown Voltage 漏極-源極擊穿電壓($I_D=250\mu\text{A}, V_{GS}=0\text{V}$)	BV_{DSS}	100	—	—	V
Gate Threshold Voltage 柵極開啓電壓($I_D=250\mu\text{A}, V_{GS}=V_{DS}$)	$V_{GS(th)}$	1	1.5	3	V
Zero Gate Voltage Drain Current 零柵壓漏極電流($V_{GS}=0\text{V}, V_{DS}=80\text{V}$)	I_{DSS}	—	—	1	μA
Gate Body Leakage 柵極漏電流($V_{GS}=\pm 20\text{V}, V_{DS}=0\text{V}$)	I_{GSS}	—	—	± 100	nA
Static Drain-Source On-State Resistance 靜態漏源導通電阻($I_D=1\text{A}, V_{GS}=10\text{V}$) ($I_D=0.8\text{A}, V_{GS}=4.5\text{V}$)	$R_{DS(ON)}$	—	520 550	630 720	$\text{m}\Omega$
Source Drain Current 源極-漏極電流	I_{SD}	—	—	1	A
Diode Forward Voltage Drop 內附二極管正向壓降($I_{SD}=1\text{A}, V_{GS}=0\text{V}$)	V_{SD}	—	—	1.2	V
Input Capacitance 輸入電容 ($V_{GS}=0\text{V}, V_{DS}=50\text{V}, f=1\text{MHz}$)	C_{ISS}	—	100	—	pF
Common Source Output Capacitance 共源輸出電容($V_{GS}=0\text{V}, V_{DS}=50\text{V}, f=1\text{MHz}$)	C_{OSS}	—	13	—	pF
Gate Source Charge 柵源電荷密度 ($V_{DS}=50\text{V}, I_D=1\text{A}, V_{GS}=10\text{V}$)	Q_{gs}	—	0.4	—	nC
Gate Drain Charge 柵漏電荷密度 ($V_{DS}=50\text{V}, I_D=1\text{A}, V_{GS}=10\text{V}$)	Q_{gd}	—	0.8	—	nC
Turn-On Delay Time 開啓延遲時間 ($V_{DS}=50\text{V}, I_D=1\text{A}, R_{GEN}=3\Omega, V_{GS}=10\text{V}$)	$t_{d(on)}$	—	5	—	ns
Turn-On Rise Time 開啓上升時間 ($V_{DS}=50\text{V}, I_D=1\text{A}, R_{GEN}=3\Omega, V_{GS}=10\text{V}$)	t_r	—	4	—	ns
Turn-Off Delay Time 關斷延遲時間 ($V_{DS}=50\text{V}, I_D=1\text{A}, R_{GEN}=3\Omega, V_{GS}=10\text{V}$)	$t_{d(off)}$	—	12	—	ns
Turn-On Fall Time 開啓下降時間 ($V_{DS}=50\text{V}, I_D=1\text{A}, R_{GEN}=3\Omega, V_{GS}=10\text{V}$)	t_f	—	5	—	ns



■ TYPICAL CHARACTERISTIC CURVE 典型特性曲线

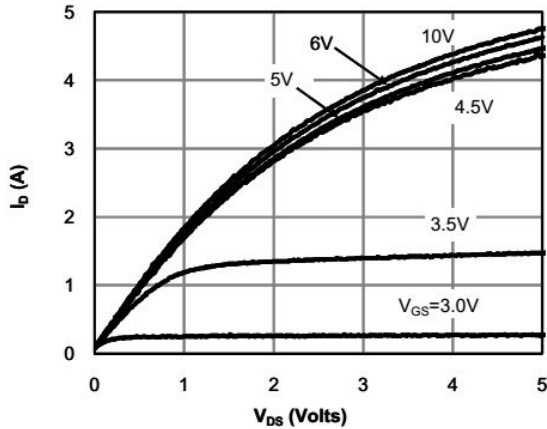

Figure 1. Output Characteristics

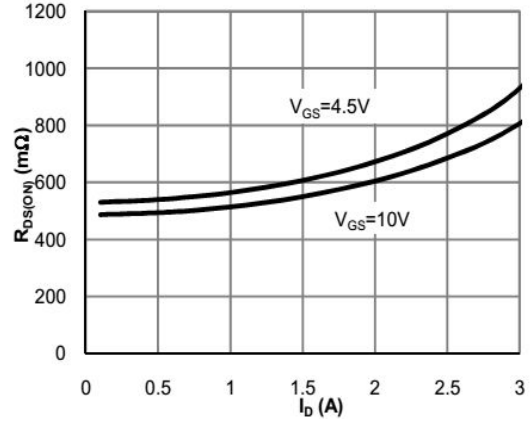

Figure 2. On-Resistance Characteristics

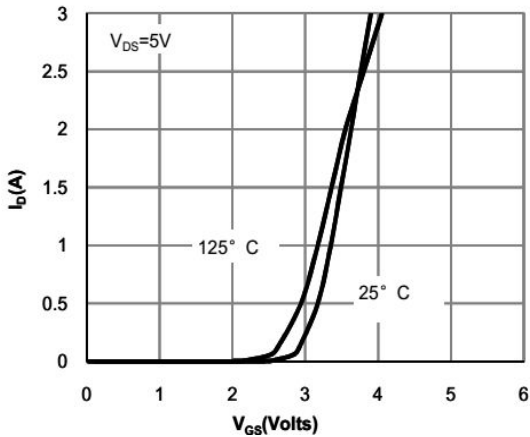

Figure 3. Transfer Characteristics

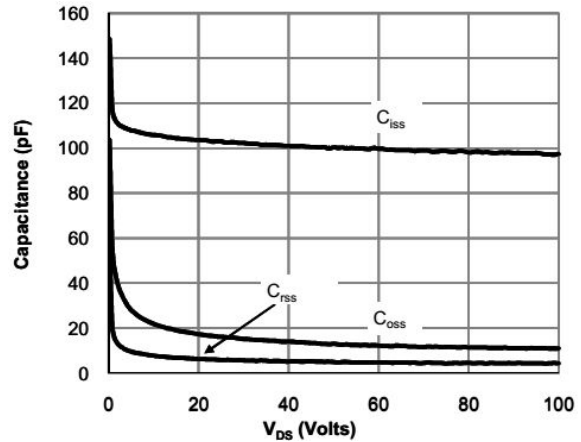

Figure 4. Capacitance Characteristics

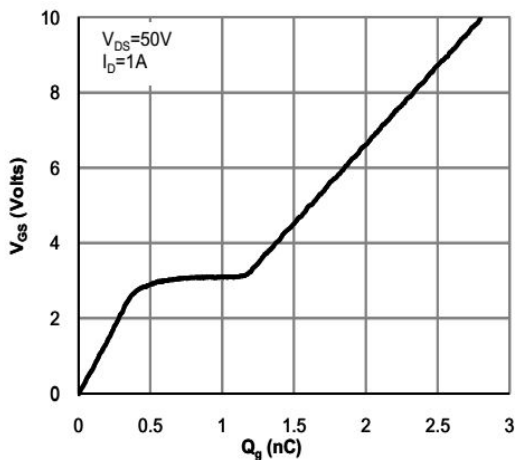

Figure 5. Gate charge

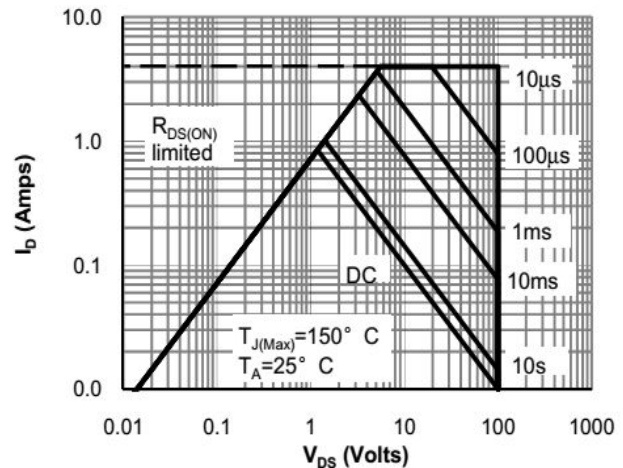

Figure 6. Maximum V_{DS} Safe Operating Area